

BIOSWING® Rollstativ 20

Montage und Bedienungsanleitung

Assembly and operating instructions

Instructions de montage et service



BIOSWING
Therapie- und Trainingssysteme



Beigefügtes Werkzeug / Attached tools / Outils joints

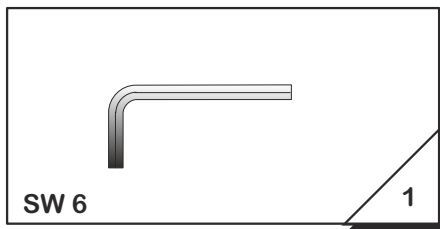

Diese Punkte fest verschrauben

Tighten fast these points

Visser fortement ces points



Diese Punkte leichtgängig verschrauben

Screw up these points easy to move

Visser légèrement ces points

Hinweis:

Die vollständigen Unterlagen und Therapieanleitungen zu den Produkten erhalten Sie auch im Internet unter - <http://www.bioswing.de/therapiesysteme> - oder - <http://www.bioswing.de/trainingssysteme> - im Download-Bereich.

Note:

You can receive in the Internet at - <http://www.bioswing.de/therapiesysteme> - or - <http://www.bioswing.de/trainingssysteme> - in the download area, the complete documents and therapy instructions to the products.

Indication:

Vous pouvez recevoir dans L'internet sous L'adresse - <http://www.bioswing.de/therapiesysteme> - ou - <http://www.bioswing.de/trainingssysteme> - dans la rubrique téléchargement L'entière documentation et les instructions du produit.

Lieferumfang
Shipment
Contenu de la livraison

Montageteile / assembly parts / pièces de montage

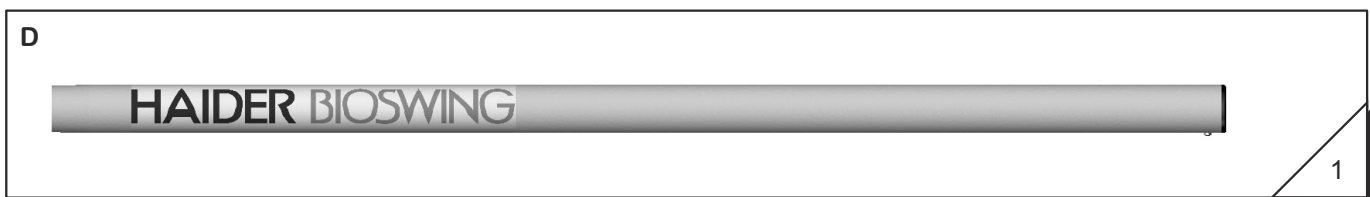
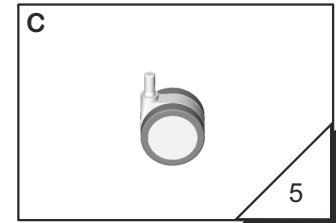
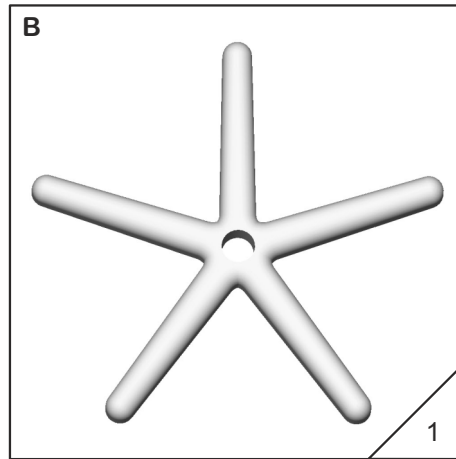
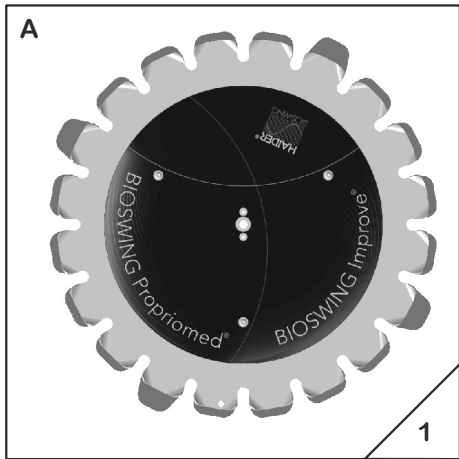

Kleinteile / small parts / pièces détachées



Abbildung in Originalgröße / illustrations shown in original size / image en dimension originale

1



2

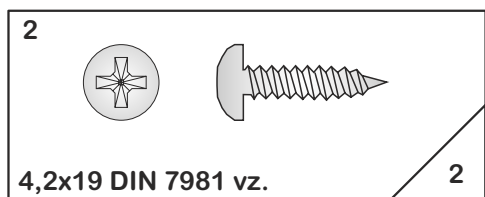
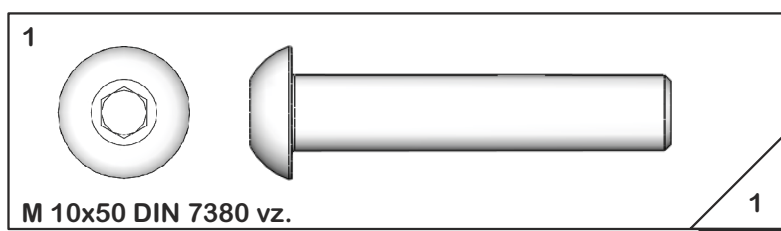
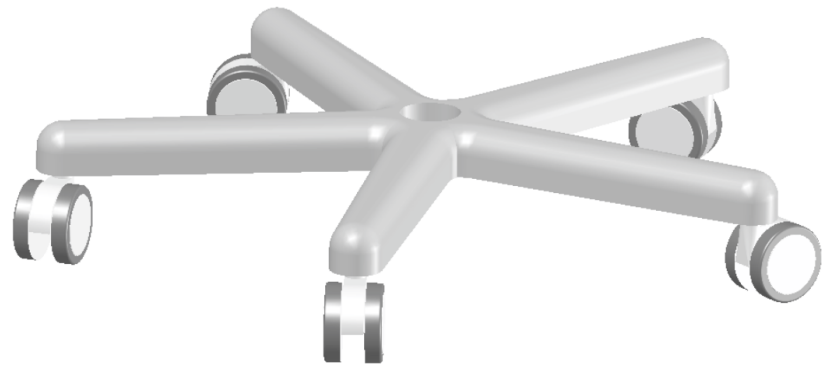
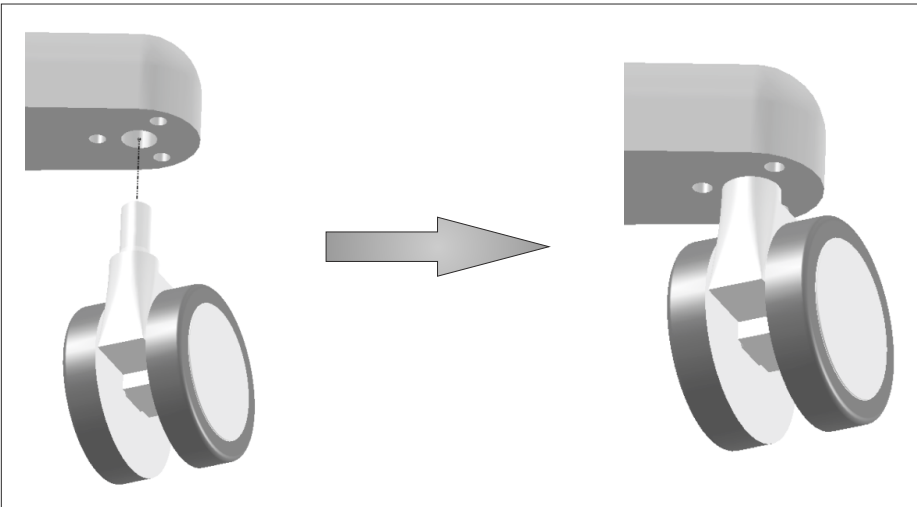
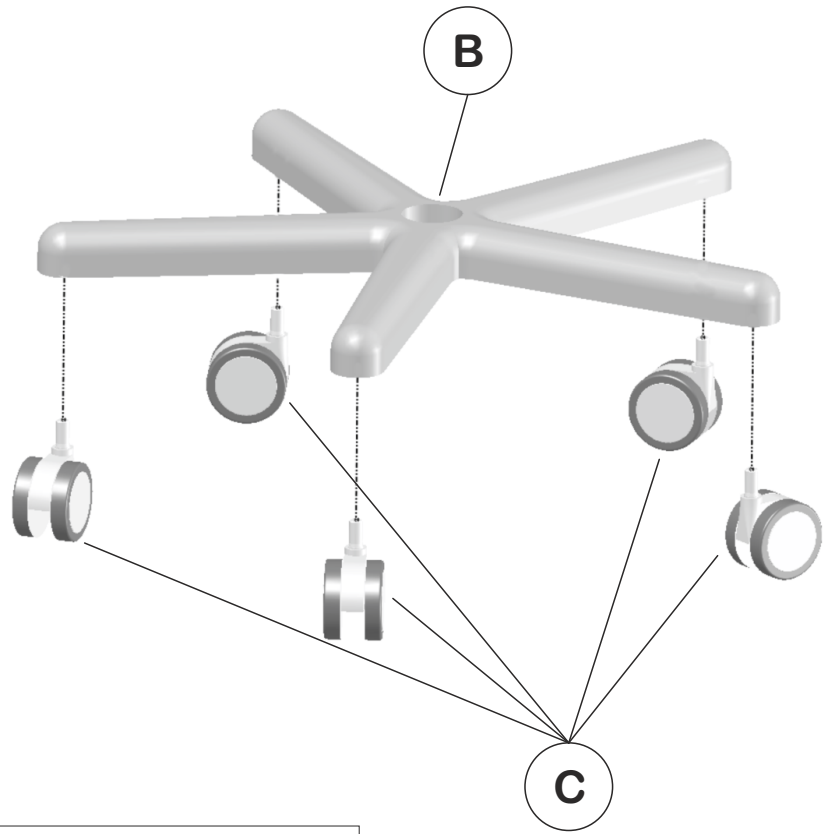
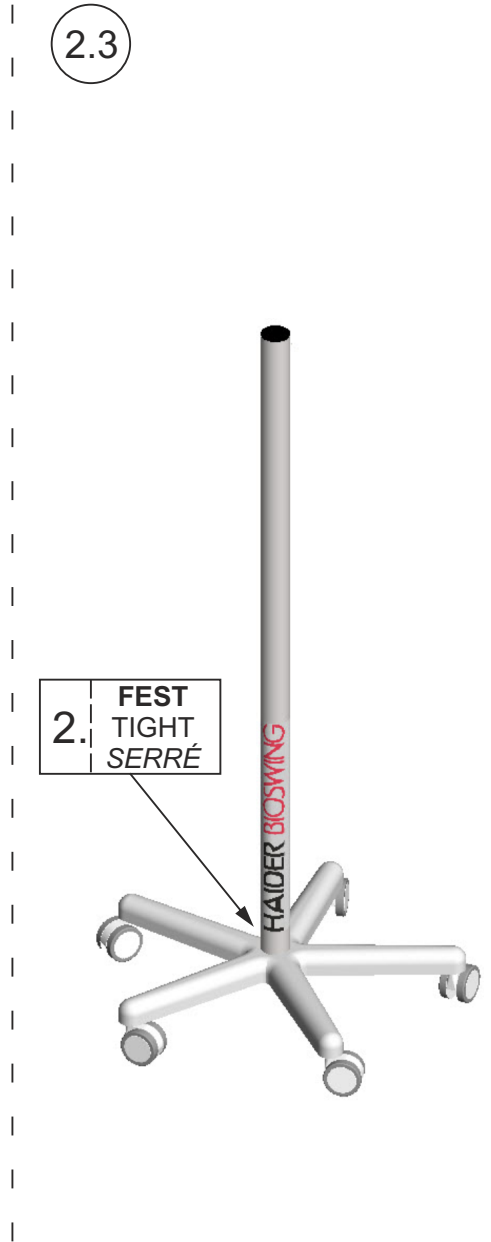
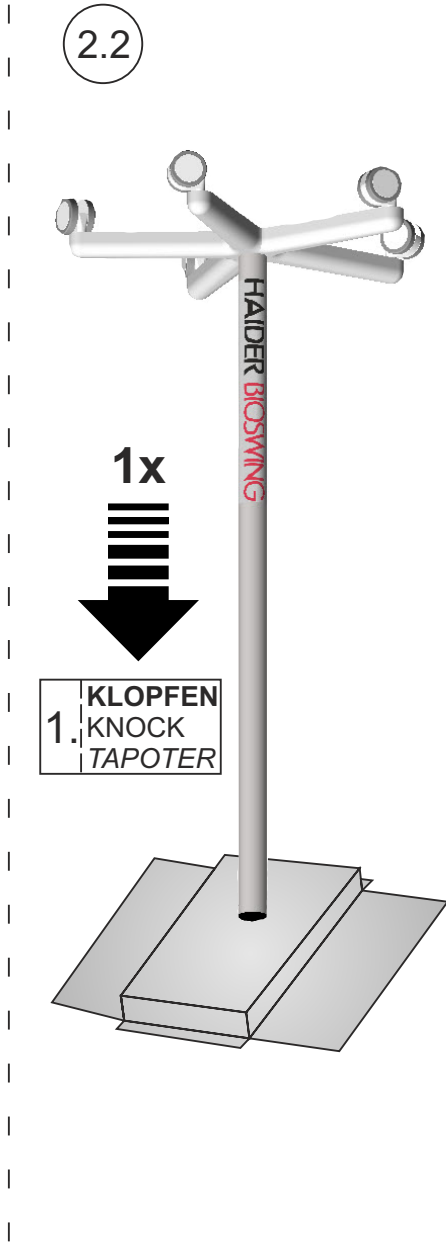
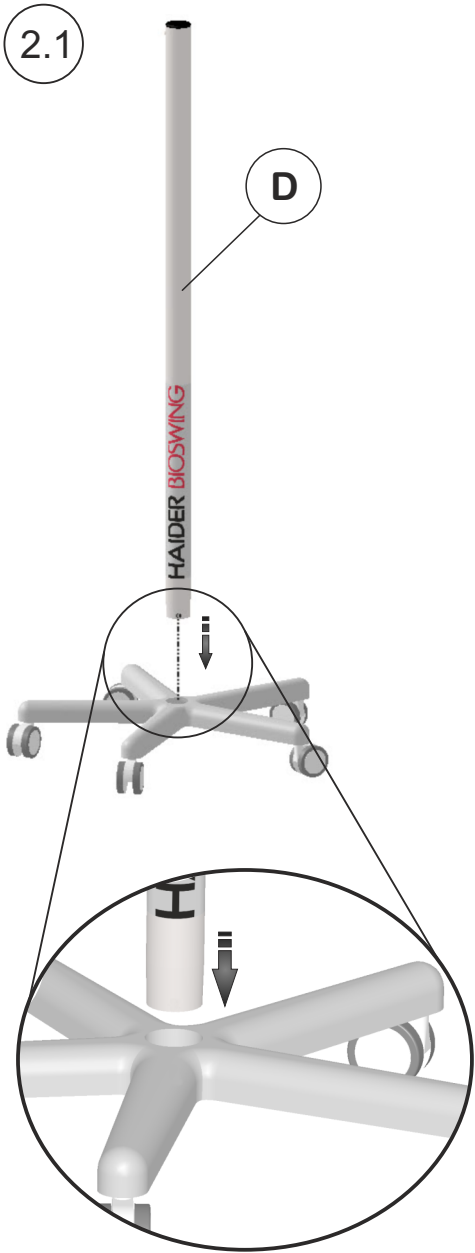

3

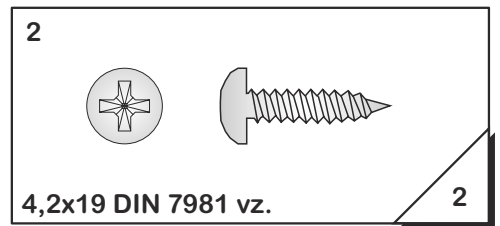
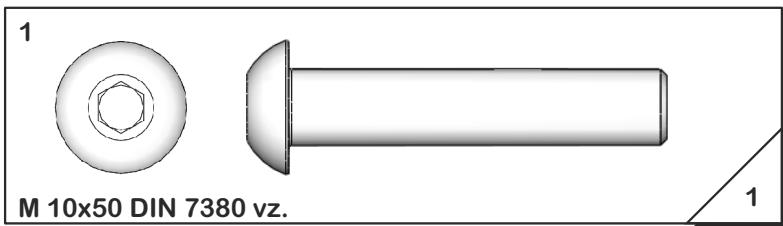
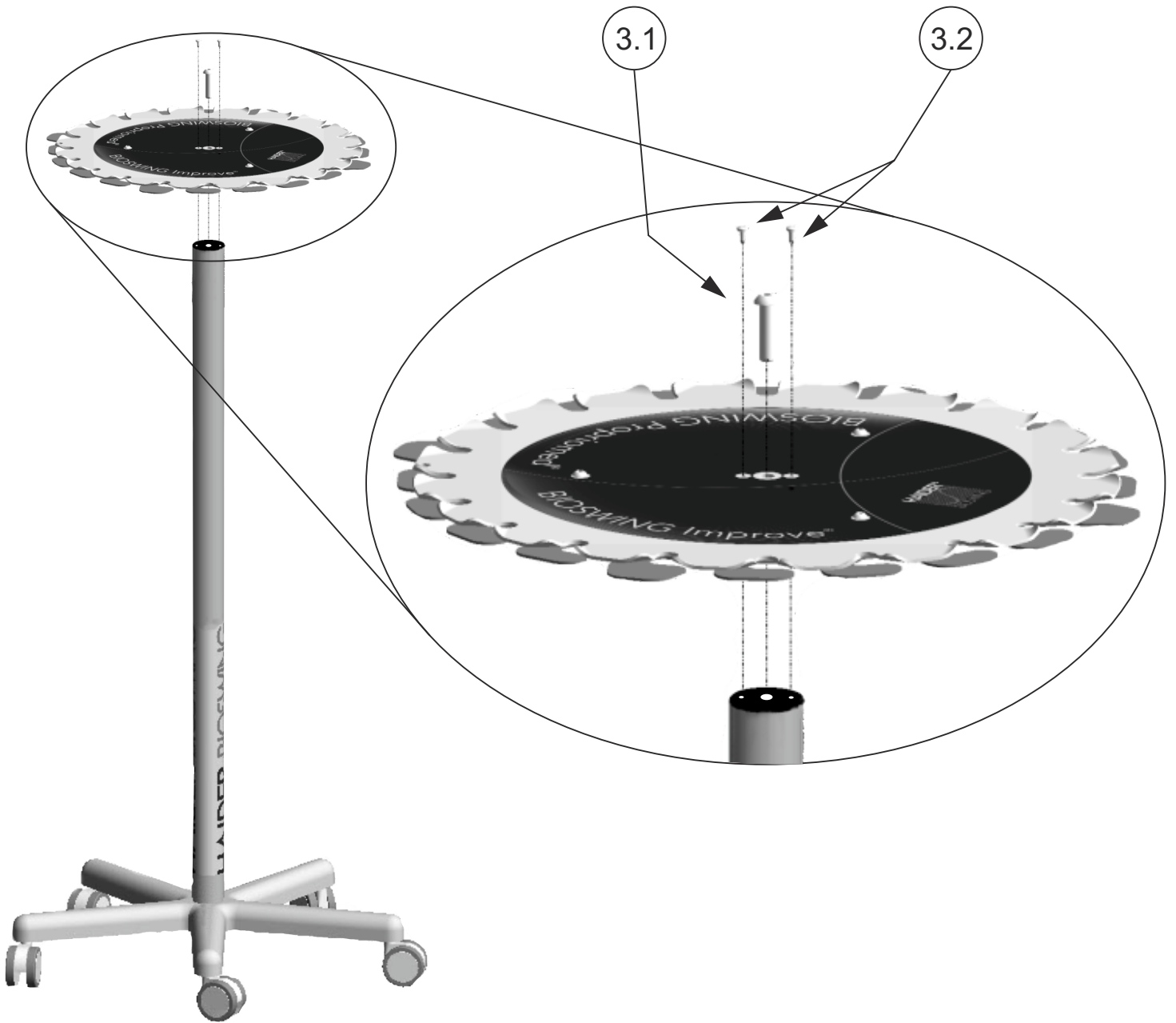

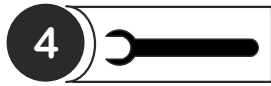

ACHTUNG !!! Bei diesem Montageschritt Schrauben fest anziehen.
ATTENTION !!! Please fasten all screws carefully now.
ATTENTION !!! à cette étape de montage visser fermement les vis

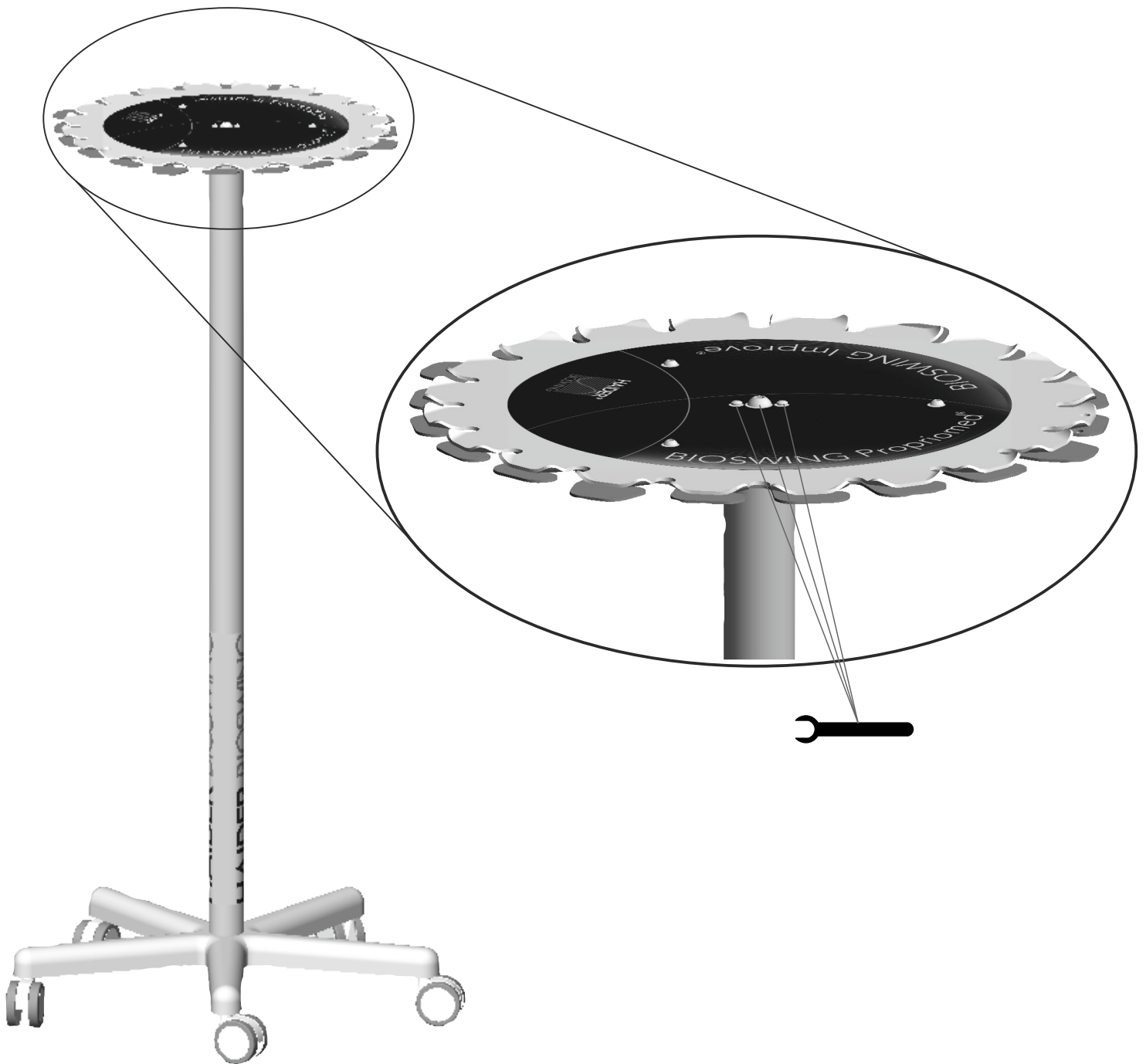

Bedienung der Verriegelung

Locking Operation

Maniement du blocage

Verriegelung

Locking

Blocage

Entriegelung

Unlocking

débloccage

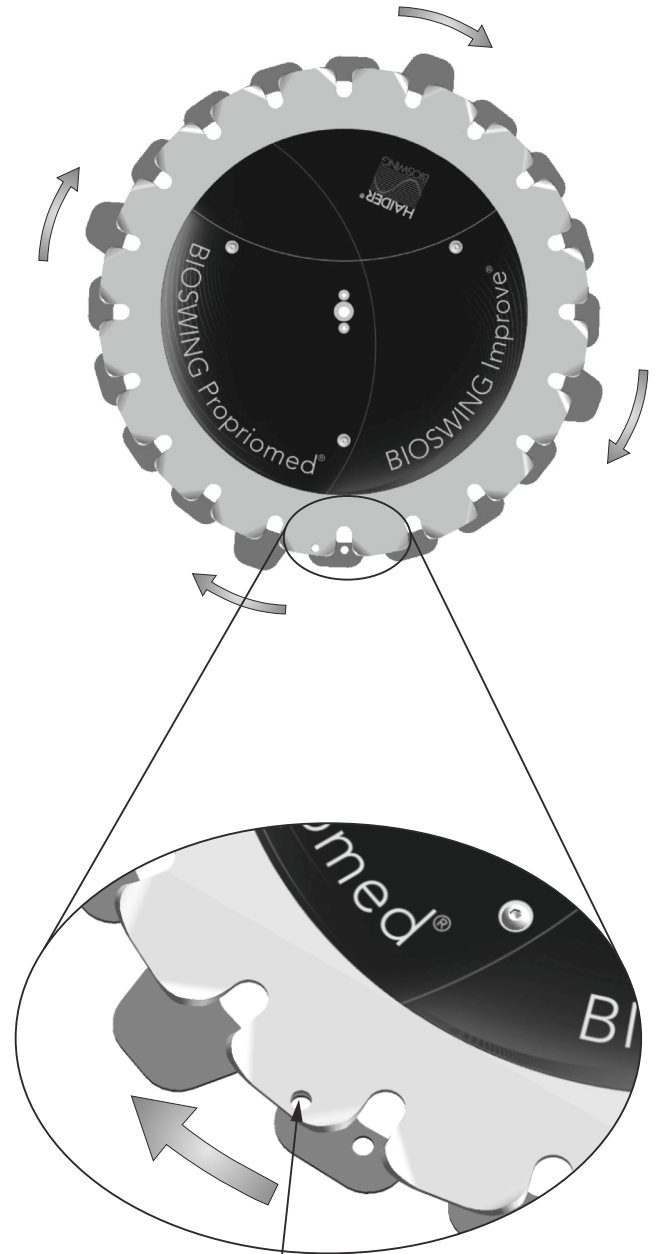
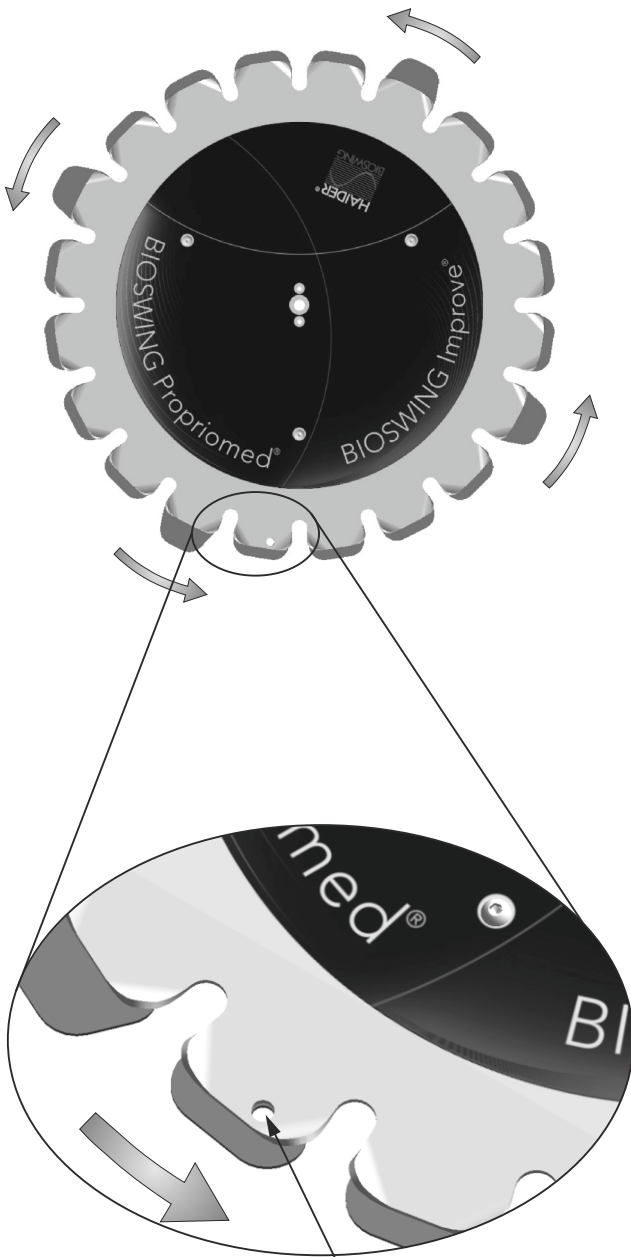

Schloß nicht im Lieferumfang!

Lock not included!

Cadenas non incluses!

Richtige Benutzung des Stativs

Correct usage of the stand

L'utilisation correcte du statif

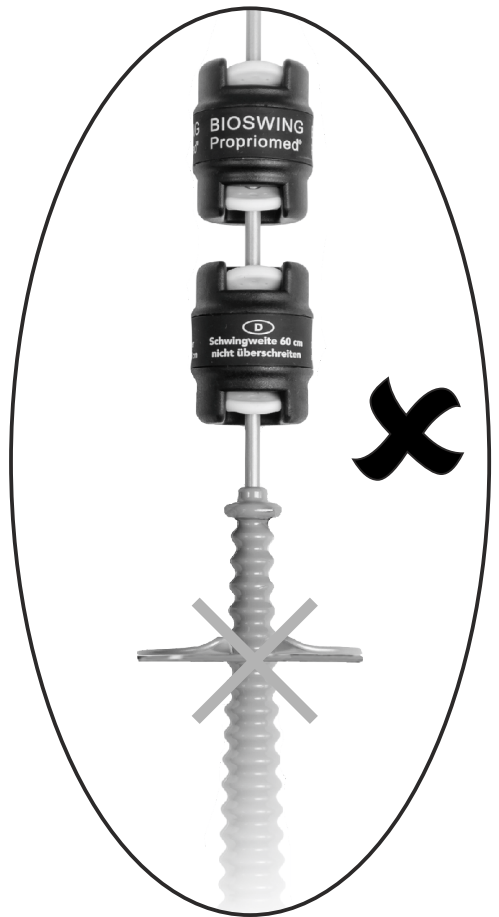
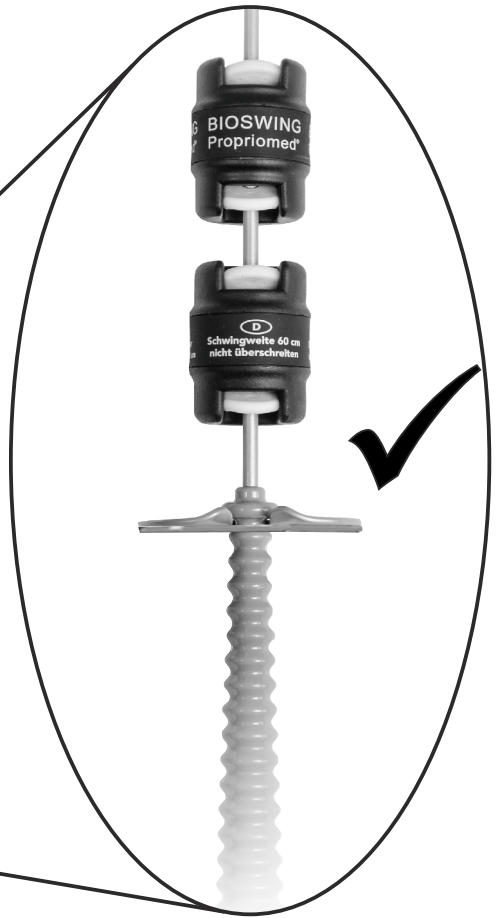
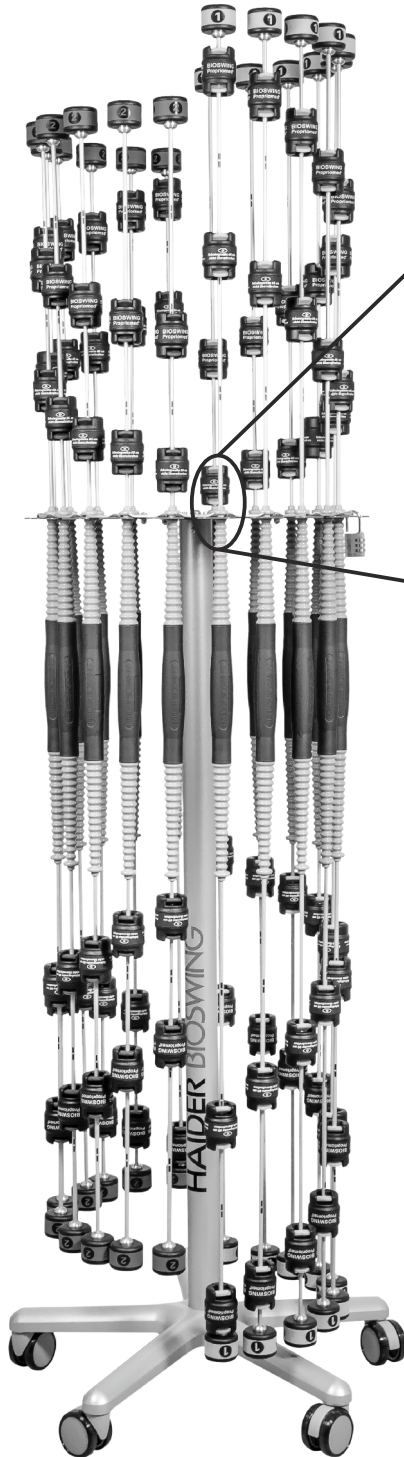

Stand: 01.12.2014
Technische Änderungen und Irrtümer vorbehalten
Date: 01.12. 2014
Subject to technical changes and errors without notice
Situation au 01.12.2014
Sous réserve de modifications techniques et d'erreurs